

3 LENS TAB-MODUL

BRAUN LIGHTING SOLUTIONS

Technical Description

- Optimized for integration into streetlights
- Connection-ready and easy-to-install module
- Simple integration into lantern
- UV-resistant High-efficiency lenses made of PMMA
- Highest possible efficiency of all system components
- Fulfills protection rating IP 68
- Dimmable

Optional

- temperature monitoring (ThermoProtect)

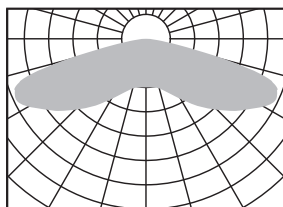
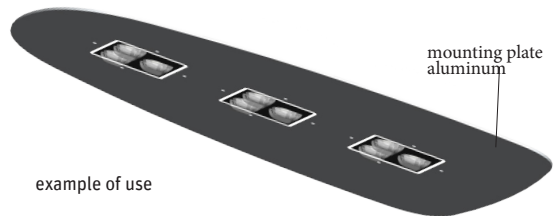
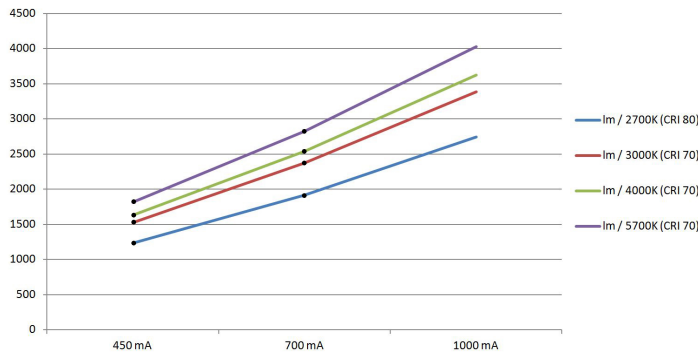
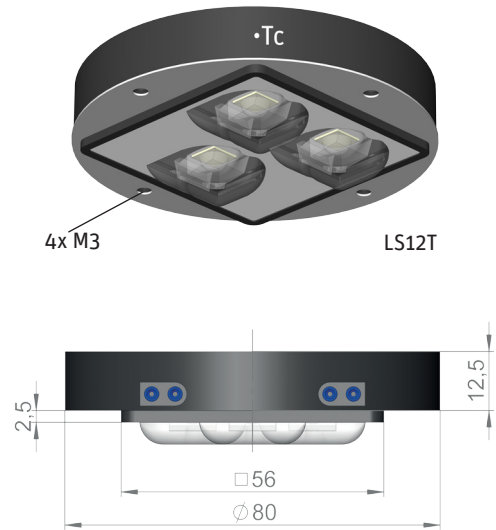

LS12 ME 600

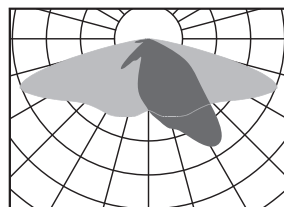

LS12 ME 612

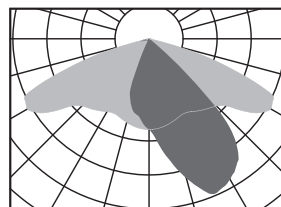

LS12 ME 618

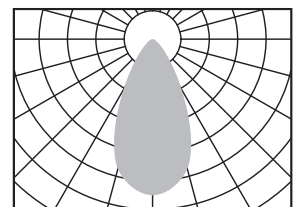

LS12 ME 624

| Order No. | CRI Min. | Kelvin (typisch) | Power Input (typical) | | Light Flux (HOT Lumens @ Tj 85° C including optical losses) | | Voltage (DC) (typical) | | Expected Life (hrs) L70 |
|----------------|----------|------------------|-----------------------|---------|---|---------|------------------------|--------|-------------------------|
| | | | W@450mA | W@700mA | @450mA | @700mA | @450mA | @700mA | |
| LS12 ME *xxx 2 | 80 | 2700 | 14,9 W | 23,5 W | 1233 lm | 1918 lm | 32,7 V | 33,6 V | 50.000 |
| LS12 ME *xxx 3 | 70 | 3000 | 14,9 W | 23,5 W | 1523 lm | 2369 lm | 32,7 V | 33,6 V | 50.000 |
| LS12 ME *xxx 4 | 70 | 4000 | 14,9 W | 23,5 W | 1632 lm | 2538 lm | 32,7 V | 33,6 V | 50.000 |
| LS12 ME *xxx 5 | 70 | 5700 | 14,9 W | 23,5 W | 1813 lm | 2820 lm | 32,7 V | 33,6 V | 50.000 |

*XXX = 600, 612, 618, 624

To comply with the data sheet specifications is the temperature at the Tc-point observed by <75°C. The module does not require any glass covering. Braun Lighting Solutions e. K. is a participant in the export initiative "Energie Effizienz – made in Germany", initiated by the Federal Ministry for the Economy and Technology. Due to the complexity of the many possible combinations of drivers and LED modules, the values shown for technical LED parameters, including performance parameters, are typical. Actual values of specific products in specific configurations may vary from these typical values. The information and diagrams contained in this document do not constitute an offer or contractual obligation. Product parameters may change as a result of technical innovation and will be undertaken without prior notice. Our manufacturing conforms to DIN EN and VDE regulations; the product conforms to European EMC regulations.